

TOUCH SCREEN THERMOSTAT

Firmware Version V2.0

- The enclosed thermostat provides the latest in automated touch screen technology for effortless control of your heat transfer system.
- The large screen is designed to measure the indoor air temperature using a high precision built in sensor.
- The user has full control over the desired temperature setting and the system automatically adjusts the fan speed to achieve your desired result, transferring excess heat to the other rooms in your home.
- With the added functionality of the timer, your system has the ability to turn off when you choose.



Important

Please ensure these instructions are read thoroughly before commencing installation and that all documentation is left with the home owner on completion of installation

- This appliance is not intended for use by persons (including children) with reduced physical, sensory or mental capabilities, or lack of experience and knowledge, unless they have been given supervision or instruction concerning use of the appliance by a person responsible for their safety.
- Children should be supervised to ensure that they do not play with the appliance.
- Precautions must be taken to avoid the back-flow of gases into the room from the open flue of gas or other open-fire appliances when mounted in outside walls or soffits.
- Isolate the mains supply before making any electrical connections. This system should be installed by a qualified electrician.
- All wiring must comply with national wiring rules
- A means of mains power isolation must be installed in the circuit for the purpose of safe access for any internal cleaning, recalibration or maintenance.
- All electrical, electronic and mechanical parts must be installed and all ducting secured before applying mains supply.
- Isolate the mains supply before attempting to replace the system's air filter.

Selecting the Mounting Location

The thermostat should be located in the heat source room where the air temperature can be sensed as accurately as possible and not be adversely affected by direct solar radiation or convection currents.

- The thermostat should be installed inside only.
- Mount ~1.5 metres above the floor on an inner wall preferably opposite the heat source.
- Avoid locations which are not generally affected by changes in the room temperature.
- Do not install in wet/damp areas (i.e. laundry or bathrooms), on hot surfaces or exposed to direct sunlight.

Mounting Instructions and Installation

1. Cut an opening in the wall for flush box and mount it.
2. Run the electrical cable from the roof cavity down to the flush box.
3. Wire the cable to the back power module of the thermostat and wire as per the wiring diagram below.
4. Separate the front screen of the thermostat from the back module by carefully inserting a flat head screwdriver into the slot and gently levering the handle upwards.
5. Mount the power module to the flush box using the screws provided.

CAUTION: Using incorrect screws, or not tightening screws sufficiently, may cause damage to the product when re-assembling.

6. Ensure the circuit board on the back module is centred so the connections between it and the front screen can line up.

CAUTION: Forcing the controller back together without correctly aligning connections will damage the product.

7. Carefully attach the front screen to the back power module. Align the top edge then rock in and listen for a click.

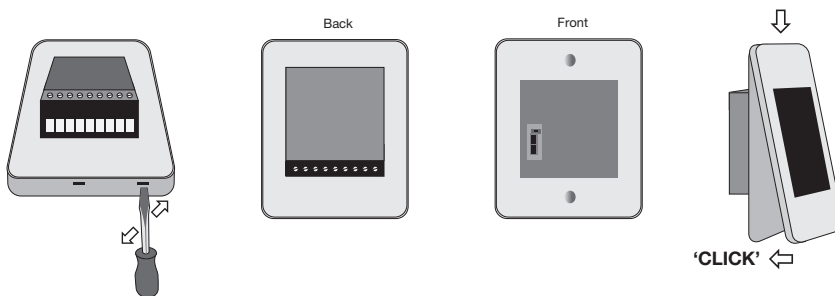

Wiring Diagrams

3 Speed

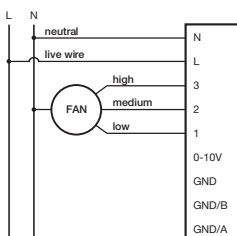

2 Speed

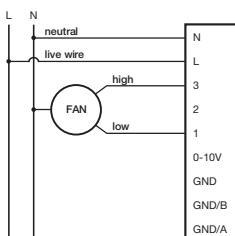

1 Speed

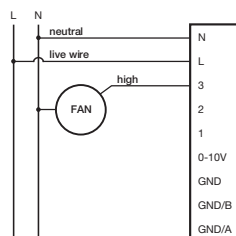













Automated Thermostat Initial Setup

All thermostats are set to the three fan speed option **003** by default and the three fan speeds available - HIGH, MEDIUM and LOW. If the fan you have purchased does not have three speeds, you can use the fan speed selector steps below to alter the fan speed as required.

AVAILABLE FAN SPEED	SELECTOR SETTING	SETTING STEPS
1	001	(see below)
2	002	(see below)
3	003	(no changes required)

Before resetting the fan selector option, turn off your thermostat by pressing down on POWER .



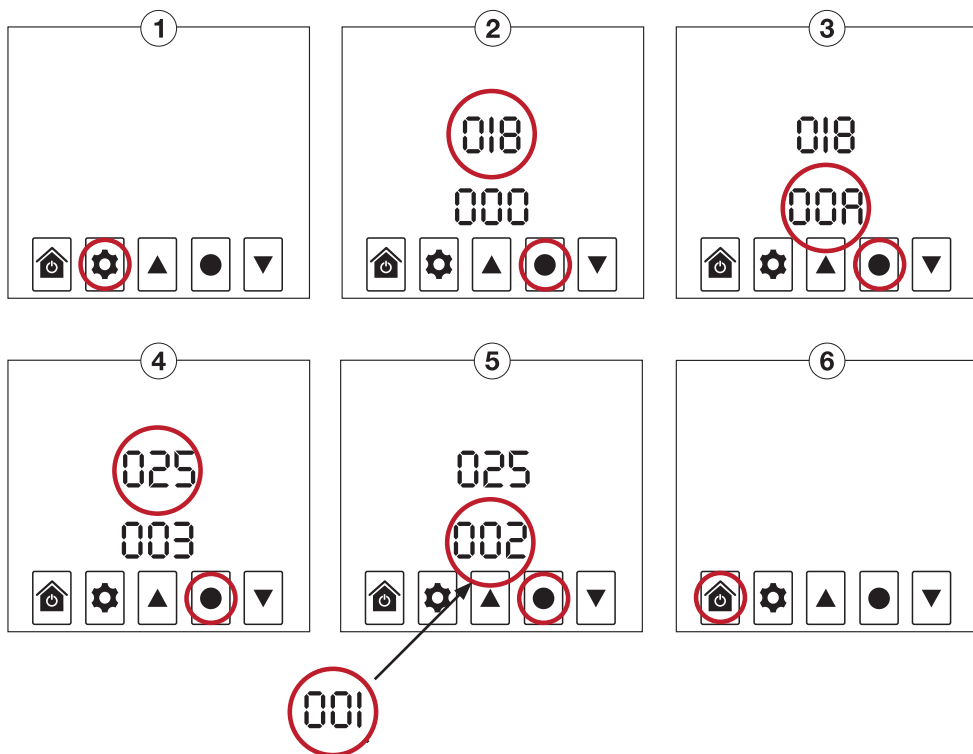

1. Press and hold SETTINGS  for 3 seconds to enter Advanced Settings
2. Press DOWN  once to see Setting **018** flashing and press SELECT .
3. Use UP  to set the installer password to **00A** and press SELECT .
4. Press UP  to go to Setting **025** and press SELECT .
5. Use UP  and DOWN  to change to fan speed **002** or fan speed **001** and press SELECT  to save changes.
6. Press POWER  to exit Advanced Settings and press POWER  again to turn the system on.

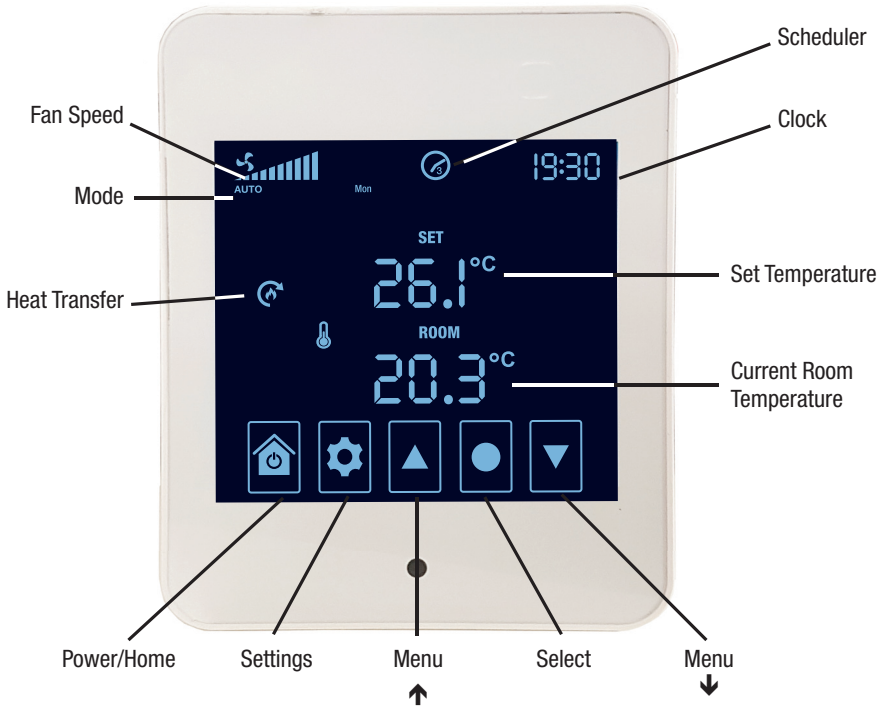

Home Screen Icons



Settings

For further control options, visit the Home Screen and press SETTINGS . You can navigate this menu by pressing UP , DOWN  and SELECT .

Button Functions in Setting Screens



Discard settings and go back to previous screen



Go back to previous parameter









Go to next parameter. Save changes when pressed on the final parameter

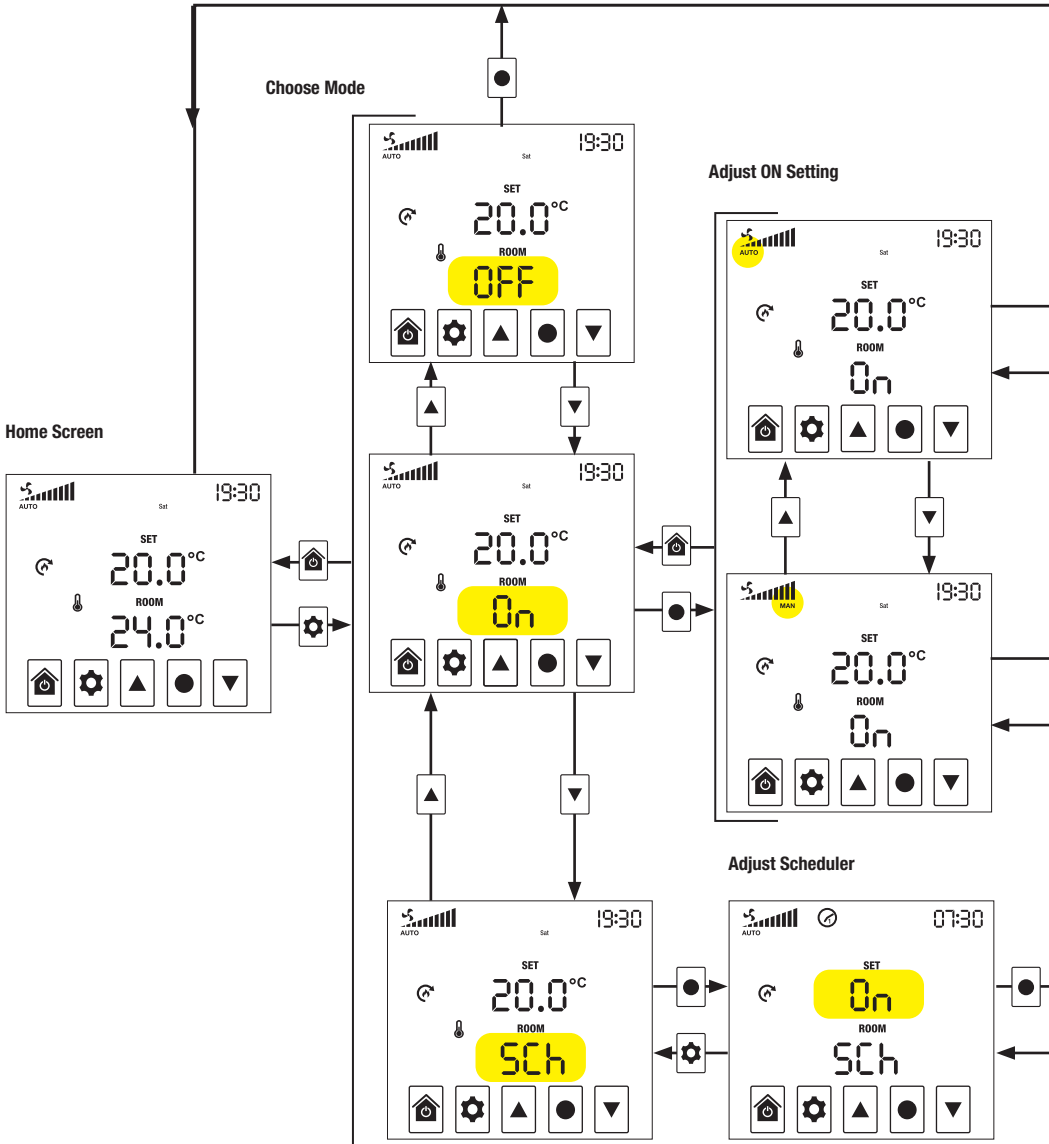





Navigate settings and adjust parameter value

Settings Map

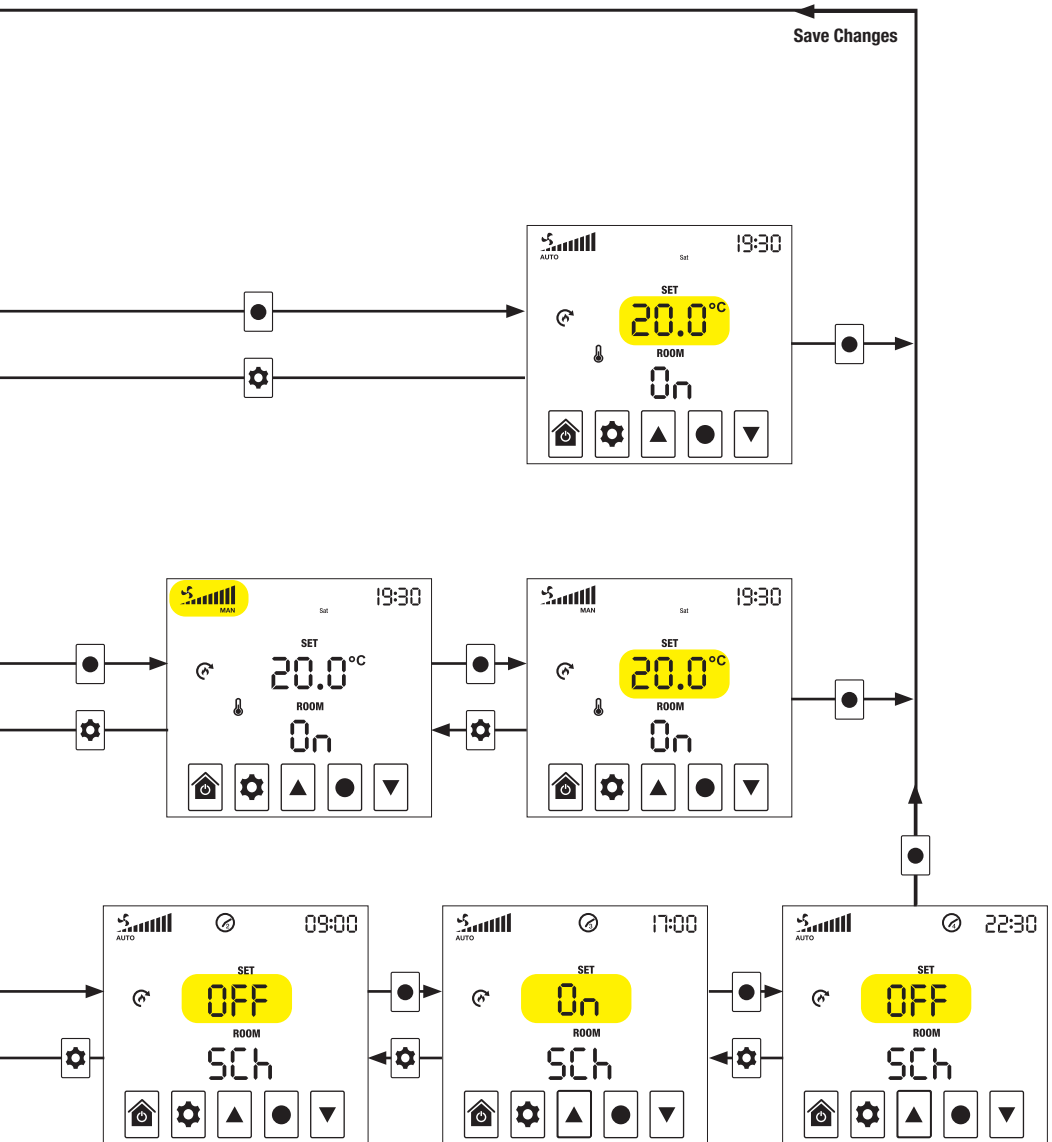

- 1 From the Home Page press **SETTINGS**  to go to mode settings selection.
2. Press **UP**  or **DOWN**  to choose the mode settings you want to change
3. Press **SELECT**  to enter into the OFF, ON or SCHEDULER mode settings.
4. Use **UP**  and **DOWN**  to change the settings.



5. Press SELECT  again to move onto the next setting of the chosen mode.
6. Press SELECT  on final mode setting to save the changes and return to the Home Page.
7. Press SETTINGS  to go back to the previous setting.
8. Press HOME  to discard changes and return to the Home Page.

Modes

OFF Mode Fan will never turn on.

ON Mode The fan will turn on when the **ROOM** temperature reaches, or goes above, your **SET** temperature. Choose between **AUTO** (Automatic) or **MAN** (Manual) fan speed.

AUTO the fan speed automatically increases as your **ROOM** temperature gets warmer.



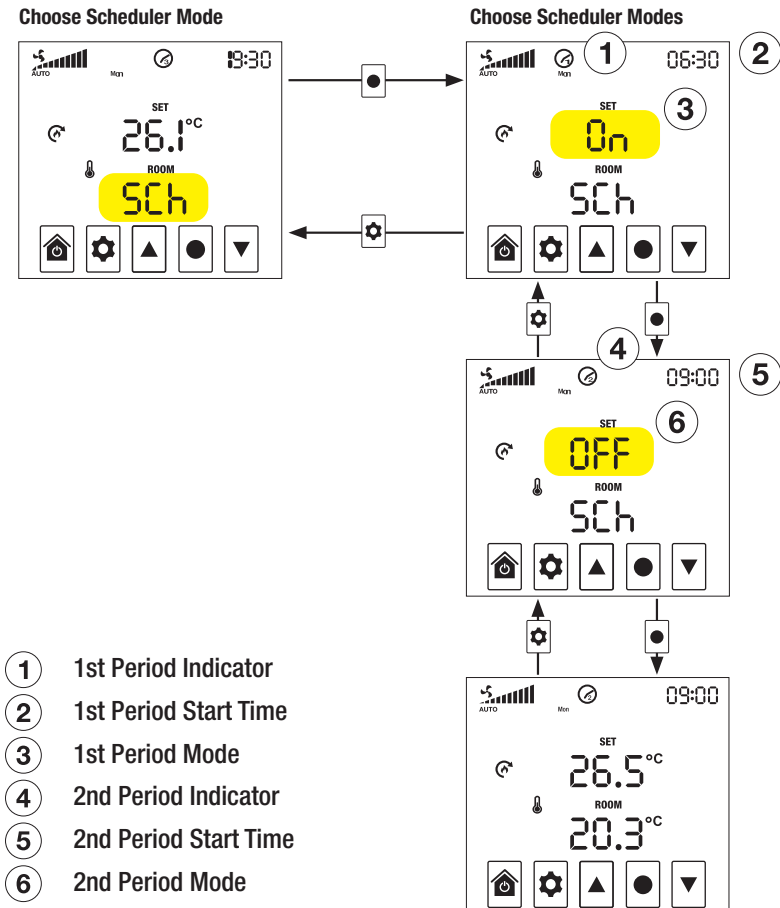

MAN the fan will turn on at your set speed.

SCH Mode Schedule when your system will be in **OFF** mode or **ON** mode. Four adjustable time periods are available. Your set mode will start at the indicated period start timer and end at the next period start time. The fourth period start time will end at the first period start time on the next day.

Tip: Set up your desired **ON** mode settings first before setting up the **SCH** mode settings.



Time-Date Setting

Hold SETTINGS  firmly for 3 seconds to enter into Time Date Settings. Press UP  and DOWN  to change settings and press SELECT  to step through settings.

HOME PAGE

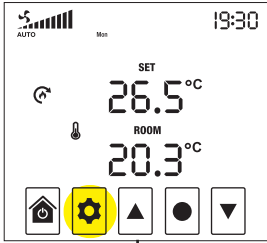

3 seconds

Hour



Minute



Day



Date



Discard Changes

Save Changes

Month

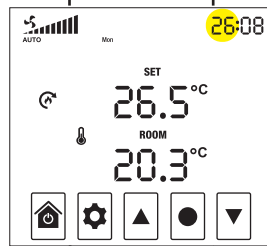





Year



To
SCHEDULER TIME
SETTING



Scheduler Time Setting

Enter the Time-Date Settings and navigate through the setup or press HOME  to enter into Scheduler Time settings. Press UP  and DOWN  to change settings and press SELECT  to step through the four schedule periods.

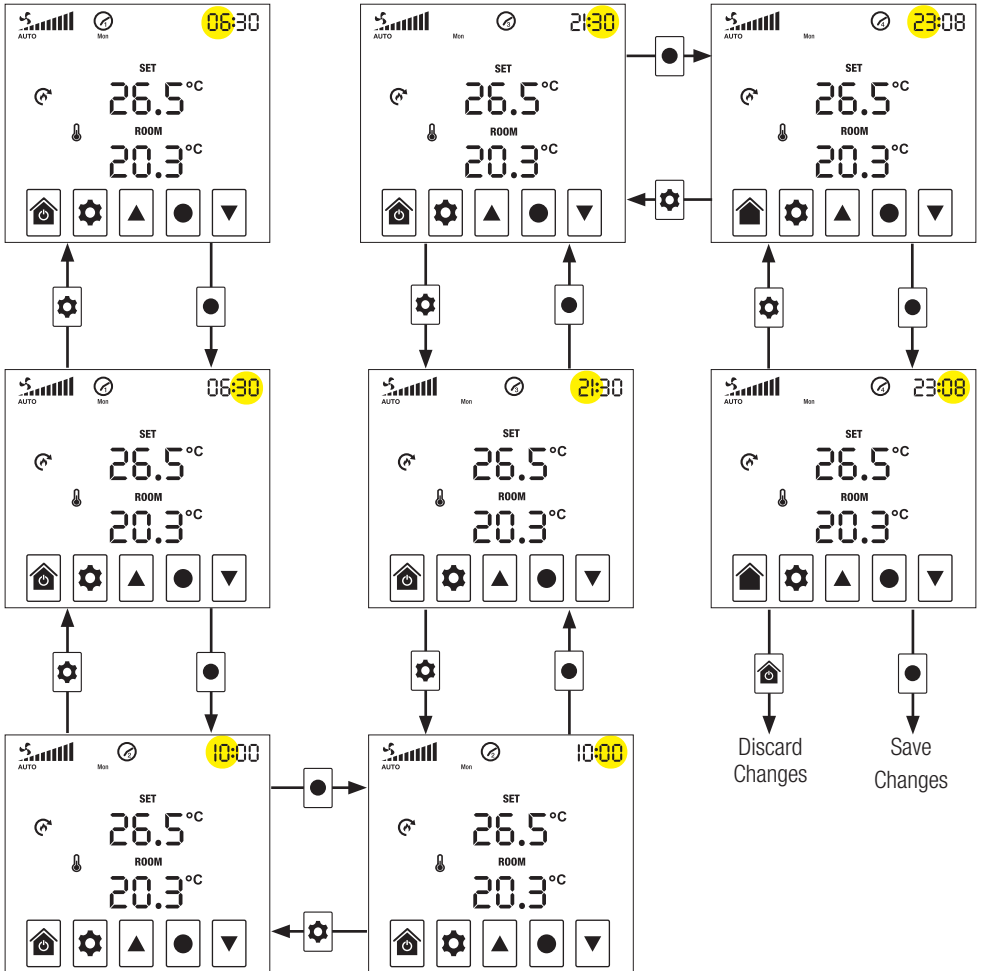





From TIME-DATE Settings



Boost Mode

From the Home Page, hold down SELECT  for 3 seconds and the system's fan will boost to HIGH speed. In BOOST mode, the time segments will become a countdown to the end of the BOOST mode. A quick tap of SELECT  on the Home Page will exit BOOST mode.

Advanced Settings

- Turn the system off, then press and hold the space where SETTINGS  would usually be for, 3 seconds, to enter into Advanced Settings.
- Navigate through the Setting Number options with UP  and DOWN .
- Press SELECT  to save the Setting Number required and to enter into the selection of a Setting Value.
- Navigate through the Setting Value options with UP  and DOWN .
- Press SELECT  to save the Setting Value required.

Refer to ADVANCED SETTING DETAILS for setting descriptions.

Advanced Settings

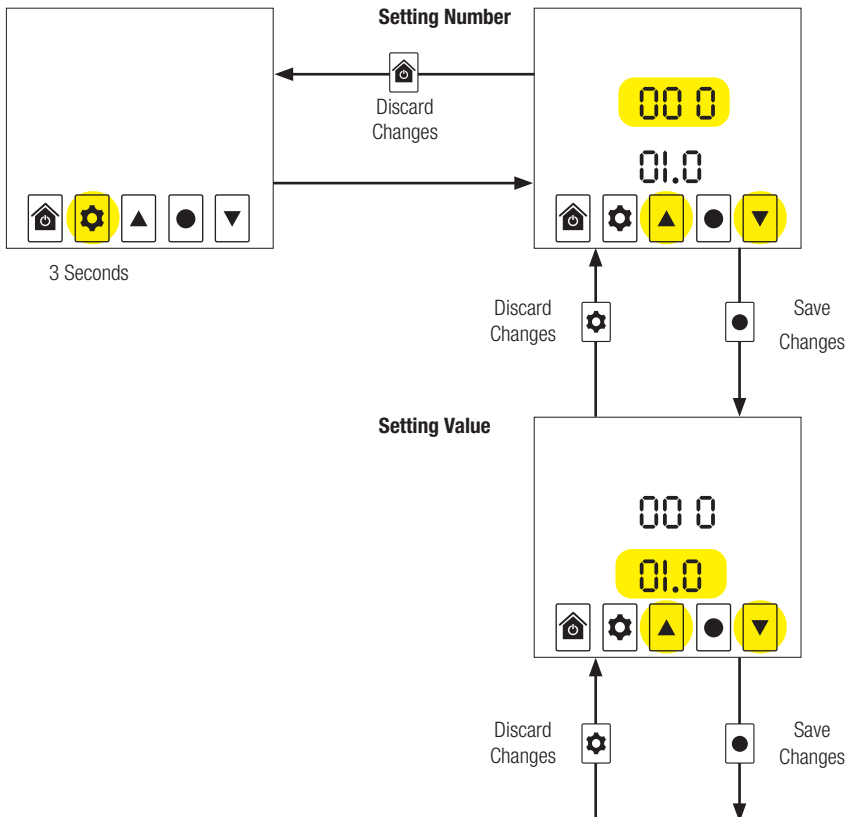

Advanced Setting Details

SETTING	DESCRIPTION	RANGE	DEFAULT	NOTE
000	Hardware Version Number	N/A	2.0	
001	Firmware Version Number	N/A	2.0	
002	Room Temperature Offset	-9°C - 9°C	-1.5°C	
003	Room Temperature Offset	-5°C - 5°C	1.0°C	
004	Screen Brightness - Maximum	0°C - 100°C	80%	
005	Screen Brightness - Minimum	0°C - 100°C	20%	
006	Boost Timer Time	0 min – 60 min	20 min	
007	Recycle Enable	0- 1	1	
008	Recycle Speed	0 - 100%	0%	
009	Recycle Temperature - Maximum	20°C - 50°C	30°C	
010	Recycle Temperature - Minimum	0-Recycle Max. Temp	5°C	
011	Temperature Set Times Hold	0°C - 5°C	1.5°C	
012	Temperature Set Differential	-5°C - 20°C	5.0°C	
013	Heat Transfer Speed Threshold - High	0°C - 10°C	5.0°C	
014	Heat Transfer Speed Threshold - Low	0°C - 10°C	5.0°C	
015	Filter Percentage	N/A	2.0°C	
016	Filter Reset	N/A	0	
017	Restore User Settings ☆	0 - 1	0	1 = restore
018	Installer Password	N/A	0	
019	Reserved	N/A	0	Do not change!
020	Reserved	N/A	1	Do not change!
021	Reserved	N/A	0	Do not change!
022	Reserved	N/A	0	Do not change!
023	Reserved	N/A	0	Do not change!
024	Fan Type	0 - 1	0	
025	Number of Fan Speeds	1 - 3	3	
026	Reserved	N/A	0	Do not change!
027	Key Sensitivity - Power	15 - 125	43	CAUTION*
028	Key Sensitivity - Setting	15 - 125	42	CAUTION*
029	Key Sensitivity - Up	15 - 125	45	CAUTION*
030	Key Sensitivity - Select	15 - 125	45	CAUTION*
031	Key Sensitivity - Down	15 - 125	45	CAUTION*
032	EC Fan Speed Setting - Low	0 - 100%	30%	
033	EC Fan Speed Setting - Medium	0 - 100%	50%	
034	EC Fan Speed Setting - High	0 - 100%	80%	
035	EC Fan Speed Setting - Boost	0 - 100%	100%	

* **CAUTION:** It is possible to render buttons inoperable and irrecoverable by adjusting the values. Adjust at your own risk.
The lower the value the more sensitive the button, the higher the value the less sensitive the button.

☆ Restores parameters 000-017 to default settings

Technical Specifications

Touch Screen Thermostat V2.0	
Temperature Range	5-35°C adjustable
Display Resolution	1°
Operating Voltage/Frequency	220-240 V AC, 50Hz
Switching Voltage	240V AC Max
Switching Current	3A max resistive load
Sensing Element	NTC thermistor
Operating Temperature	0 to 40°C
Operating Humidity	5-90% non condensing
Live Output Isolation	Relay
Output Control	Relay
Display	3.5" digital LCD touch screen
Approval	All relevant AS/NZS standards
EMC Approval	All relevant AS/NZS standards  E6337

Specification are subject to change without notice



Distributed by Simx Limited
PO Box 14 347, Panmure, Auckland, NZ.
Technical Support (09) 259 1662 | e: sales@simx.co.nz | w: www.simx.co.nz